



TOPWAY displays

info@topwaydisplays.eu
www.topwaydisplays.eu

LMT057DCDFWU-NBA

LCD Module User Manual

Prepared by: Date:	Checked by: Date:	Approved by: Date:
---	--	---

Rev.	Descriptions	Release Date
0.1	Preliminary	2011-04-09
0.2	Revise 5.2 Back-Light Characteristics	2011-11-22

Table of Content

1. General Specification	3
2. Block Diagram.....	3
3. Input/Output Terminals.....	4
3.1 TFT LCD Panel	4
3.2 Backlight connector.....	4
3.3 Touch Panel FPC.....	4
4. Absolute Maximum Ratings	5
5. Electrical Characteristics	6
5.1 DC Characteristics	6
5.2 Back-Light Characteristics	6
5.3 Touch Panel Characteristics	6
6. AC Characteristics.....	7
7. Optical Characteristics.....	9
7.1 Optical characteristic of the LCD.....	9
8. Function Characteristics.....	11
9. Precautions of using LCD Modules.....	12

1. General Specification

Screen Size(Diagonal) :	5.7 inch
Number of dots :	640x 3 (RGB) x 480
Active Area :	115.2x86.40(mm)
Outline Dimension :	144.0x104.6x13.0 (mm) exclude Cable (See attached drawing details)
Display Mode :	Normal White mode / Transmissive / Wide view
Pixel Arrangement :	R.G.B. Vertical Stripe
Pixel Size :	181.5x181.5 (um)
Color Depth:	262K Colors
Backlight Type	LED Sidelight
Viewing Direction :	12 o'clock
Touch Panel type:	4 wire Resistive
TP Surface Treatment:	Anti-Glare
Input Interface:	18bit Parallel(R:G:B=6:6:6)
Operating Temperature :	-10 ~ +60°C
Storage Temperature :	-20 ~ +70°C

2. Block Diagram

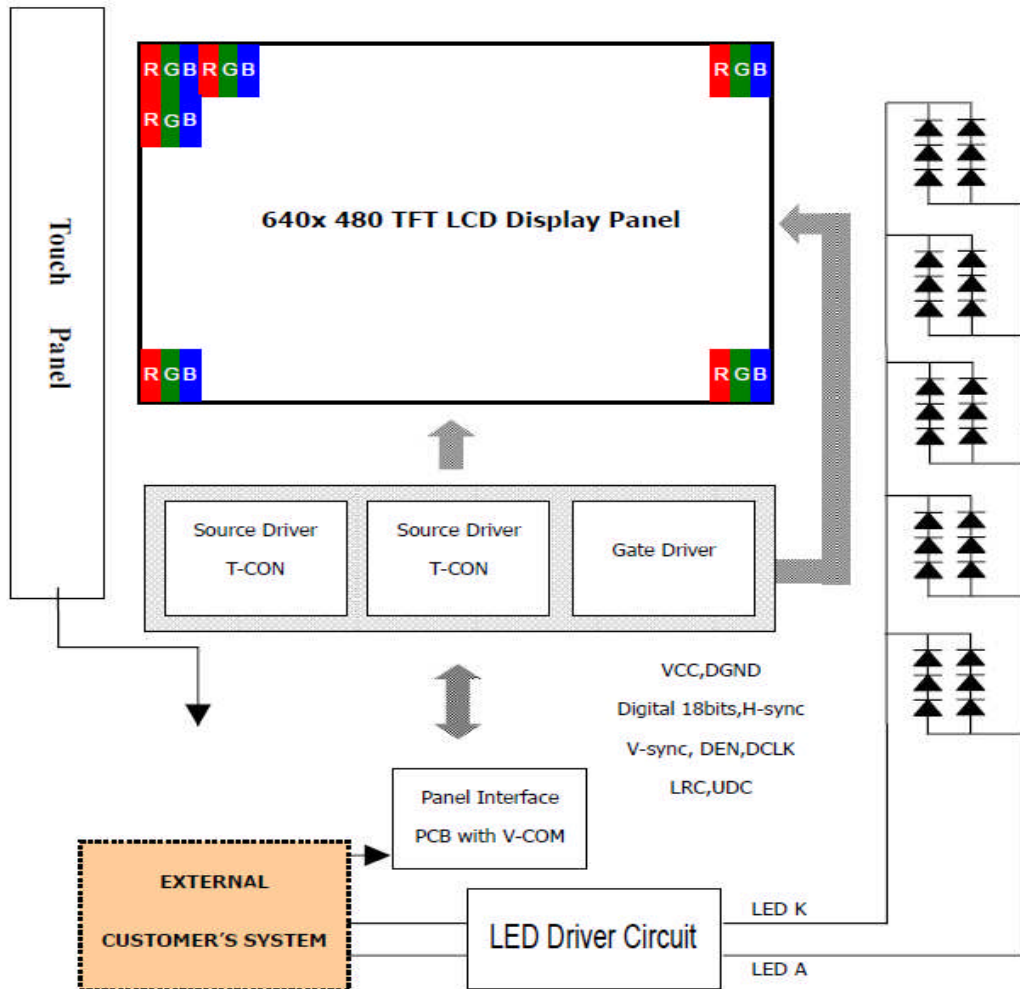

3. Input/Output Terminals

3.1 TFT LCD Panel

Pin No.	Pin Name	IO	Descriptions	Note
1	DGND	Power	Ground	
2	DCLK	Input	Clock signal for sampling each data signal	
3	Hsync	Input	Horizontal synchronous signal (Negative)	
4	Vsync	Input	Vertical synchronous signal (Negative)	
5	GND	Input	GND	
6	R0	Input	RED data signal (LSB)	
:	:	:	:	
11	R5	Input	RED data signal (MSB)	
12	GND	Power	GND	
13	G0	Input	GREEN data signal (LSB)	
:	:	:	:	
18	G5	Input	GREEN data signal (MSB)	
19	GND	Power	GND	
20	B0	Input	BLUE data signal(LSB)	
:	:	:	:	
25	B5	Input	BLUE data signal(MSB)	
26	GND	Power	GND	
27	DEN	Input	Signal to settle the horizontal display position (Positive)	*1
28	VCC	Power	3.3V power supply	
29	VCC	Power		
30	LRC	Input	Horizontal display mode select signal H: Normal; L: Left / Right reverse mode	*2
31	UDC	Input	Vertical display mode select signal L: Normal; H: Up / Down reverse mode	*2
32	NC	--	No Connection	
33	GND	Power	GND	

Note:

*1: The horizontal display start timing is settled in accordance with a rising timing of ENAB signal. In case ENAB is fixed "Low", the horizontal start timing is determined. Don't keep ENAB "High" during operation.

*2: See Function Characteristics for Details.

3.2 Backlight connector (K2) Connector: JST PHR-6 or equivalent

Pin No.	Pin Name	IO	Descriptions	Note
1	BLVCC	Power	Positive Power Supply	
2	BLVCC			
3	BLON	Input	Backlight Driver Control(*1) BLON=Hi, Backlight Driving Booster enable BLON=Lo, Backlight Driving Booster disable	
4	BLADJ	Input	Backlight dimming control(*1, *2) PWM may be used to adjust the output brightness	
5	BLGND	Power	Power Supply GND (0V)	
6	BLGND			

Note:.

*1. With built in pull up resistor, it could leave open

*2. Recommended PWM Freq. = 3kHz (active high)

3.3 Touch Panel FPC

No.	Symbol	IO	Descriptions	Note
1	YU	Passive	Touch Panel Upper Terminal	
2	XR	Passive	Touch Panel Right Terminal	
3	YD	Passive	Touch Panel Down Terminal	
4	XL	Passive	Touch Panel Left Terminal	

4. Absolute Maximum Ratings

BLGND=GND=0V, T_{OP}=25°C

Items	Symbol	Min.	Max.	Unit	Condition
Power Voltage	V _{CC}	-0.3	+5.0	V	*1
BL Supply Voltage	BLV _{CC}	-0.3	+5.5	V	
Input Voltage	V _{IN}	-0.3	V _{CC} +0.3	V	*1
Operating Temperature	T _{OP}	-10	+60	°C	*2,*3,*4
Storage Temperature	T _{ST}	-20	+70	°C	*2

*1: V_{IN} represent R0~R5, G0~G5, B0~B5, DCLK, DE

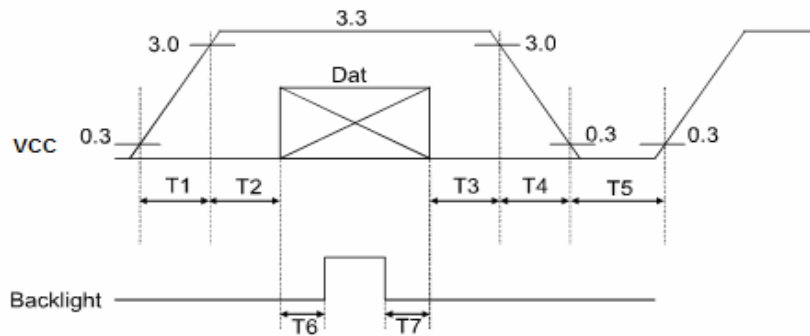

Data: DCLK, R0~R5, G0~G5, B0~B5, DE

T1 ≤ 10ms, 50ms ≤ T2, 0 < T3 ≤ 50ms, 0 < T4 ≤ 10ms, 1s ≤ T5, 200ms ≤ T6, 200ms ≤ T7

*2: 95 % RH Max. (40°C ≥ Top). Maximum wet-bulb temperature at 39°C or less. (Top > 40°C) No condensation.

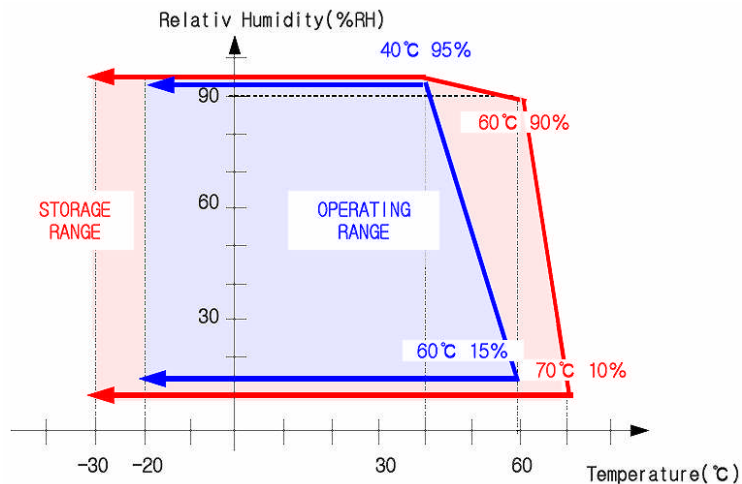

*3: In case of below 0°, the response time of liquid crystal (LC) becomes slower and the color of panel becomes darker than normal one. Level of retardation depends on temperature, because of LC's character

*4: Only operation is guaranteed at operating temperature. Contrast, response time, another display quality are evaluated at +25°C.

5. Electrical Characteristics

5.1 DC Characteristics

GND=0V, Top=25°C

Item	Symbol	Min.	Typ.	Max.	Unit	Remark
Power supply	V _{CC}	3.0	3.3	3.6	V	Note 1
Input Voltage for logic	H Level	V _{IH}	0.7V _{CC}	-	V _{CC}	V
	L Level	V _{IL}	0	-	0.3V _{CC}	V
Power Supply current	I _{CC}	-	(120)	TBD	mA	Note 2

Note1: V_{CC}-dip conditions

V_{CC}-dip conditions should also follow the V_{CC}-turn-on conditions

T_d ≤ 10ms

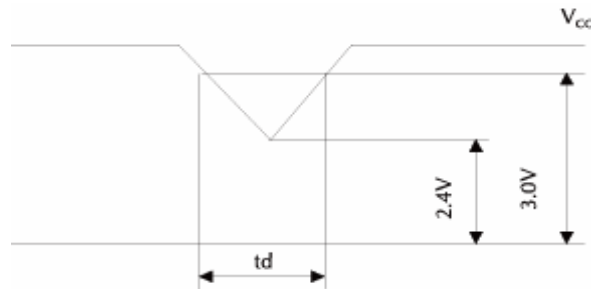

Note2: f_v =60Hz , Top=25°C , Display pattern : 64 Gray pattern

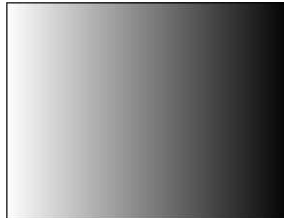

5.2 Back-Light Characteristics

BLGND=0V, BLV_{CC} =5.0, T_{OP} =25°C

Items	Symbol	MIN.	TYP.	MAX.	Unit	Applicable Pin
Operating Voltage	BLV _{CC}	4.5	5.0	5.5	V	BLVCC
Input High Voltage	V _{IH}	2.7	-	V _{CC}	V	BLON, BLADJ
Input Low Voltage	V _{IL}	GND	-	0.3	V	BLON, BLADJ
Operating Current	I _{BLVCC}	-	485.0	585.0	mA	BLVCC (*1)

Note:

*1. BLON=Hi, BLADJ=Hi

5.3 Touch Panel Characteristics

Items	Min.	Typ.	Max.	Unit	Note
Linearity	-1.5	-	2.0	%	Analog X and Y directions
Terminal resistance	150	-	800	Ω	X (Glass side)
	200	-	800	Ω	Y (Film side)
Insulation resistance	20	-	-	MΩ	DC 25V
Voltage	-	5.0	7.0	V	DC
Chattering	-	-	15	ms	100kΩ pull-up
Activation force	-	-	80	g	*1
Hitting Test	1,000,000	-	-	times	*1
Surface hardness	3	-	-	H	3H pencil, pressure 1N/45°, (JIS 5400)
Joule impact	9.0ΦDia. Steel Ball, Height=60cm 1 time, no damage. [Impact at center area]				

*1.Input in Stylus : with R8.0mm silicone rubber,250g,3 times/sec

6. AC Characteristics

Items	Symbol	Min.	Typ.	Max.	Unit	Note
CLK frequency	F_{CPH}	--	25.175	--	MHz	
CLK period	T_{CPH}	--	39.7	--	ns	
CLK pulse duty	T_{CWH}	40	50	60	%	
HS period	T_H	--	800	--	T_{CPH}	
HS pulse width	T_{WH}	5	30	--	T_{CPH}	
HS-DEN time	T_{HS}	112	144	175	T_{CPH}	
DEN pulse width	T_{EP}	--	640	--	T_{CPH}	
VS pulse width	T_{WV}	1	3	5	T_H	
VS-DEN time	T_{STV}	--	35	--	T_H	
VS period	T_V	--	525	--	T_H	

Note : When SYNC mode is used, 1st data start from 144th CLK after HS falling (when $STHD[5:0]=00000$)

Items	Symbol	Min.	Typ.	Max.	Unit	Note
OEV pulse width	T_{CVE}	--	100	--	T_{CPH}	
CKV pulse width	T_{CKV}	--	96	--	T_{CPH}	
HS-CKV time	T_1	--	52	--	T_{CPH}	
HS-OEV tim	T_2	--	8	--	T_{CPH}	
HS-POL time	T_3	--	72	--	T_{CPH}	
STV setup time	T_{SUV}	--	46	--	T_{CPH}	
STV pulse width	T_{WSTV}	--	1	--	T_H	

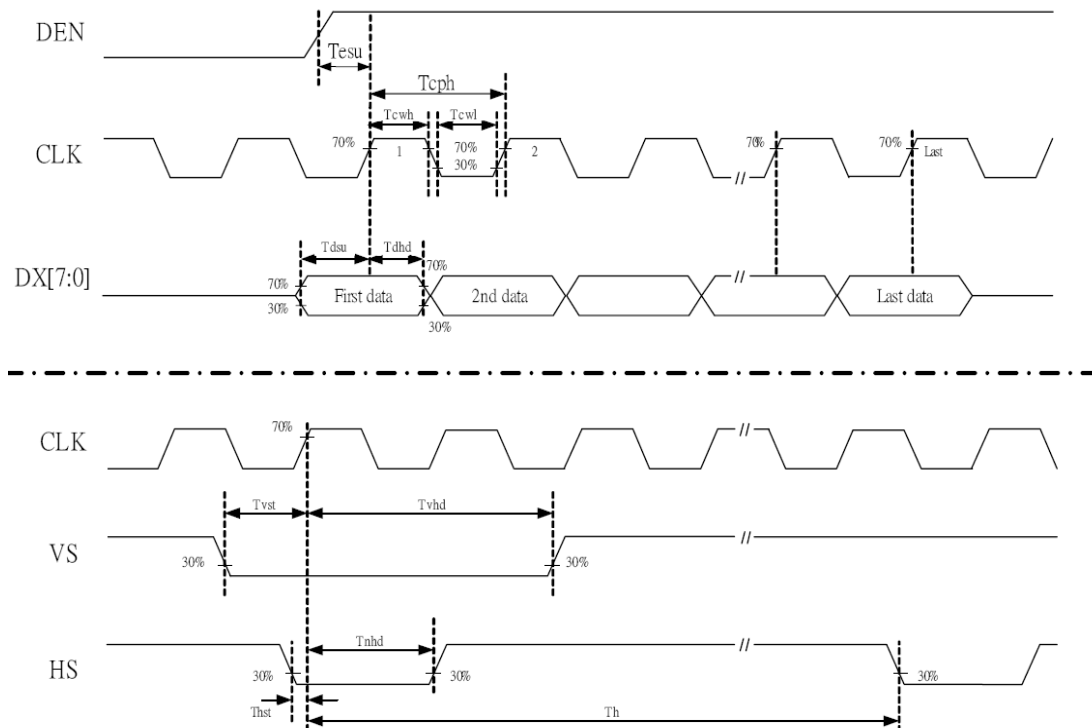

Figure6-1-1 Clock and Data input waveforms

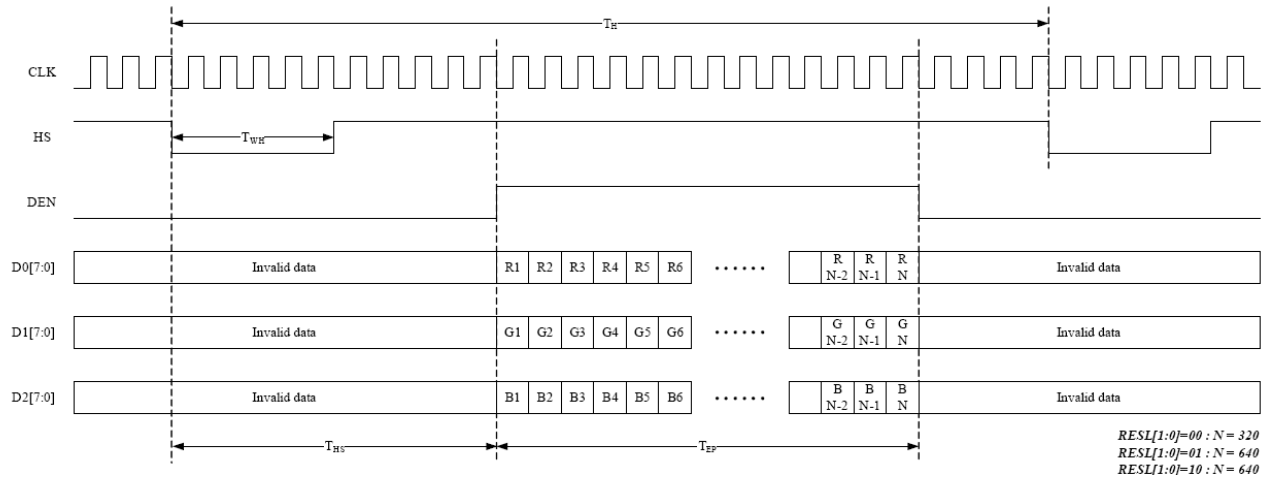

Figure6-1-2 Data input format for parallel RGB Mode

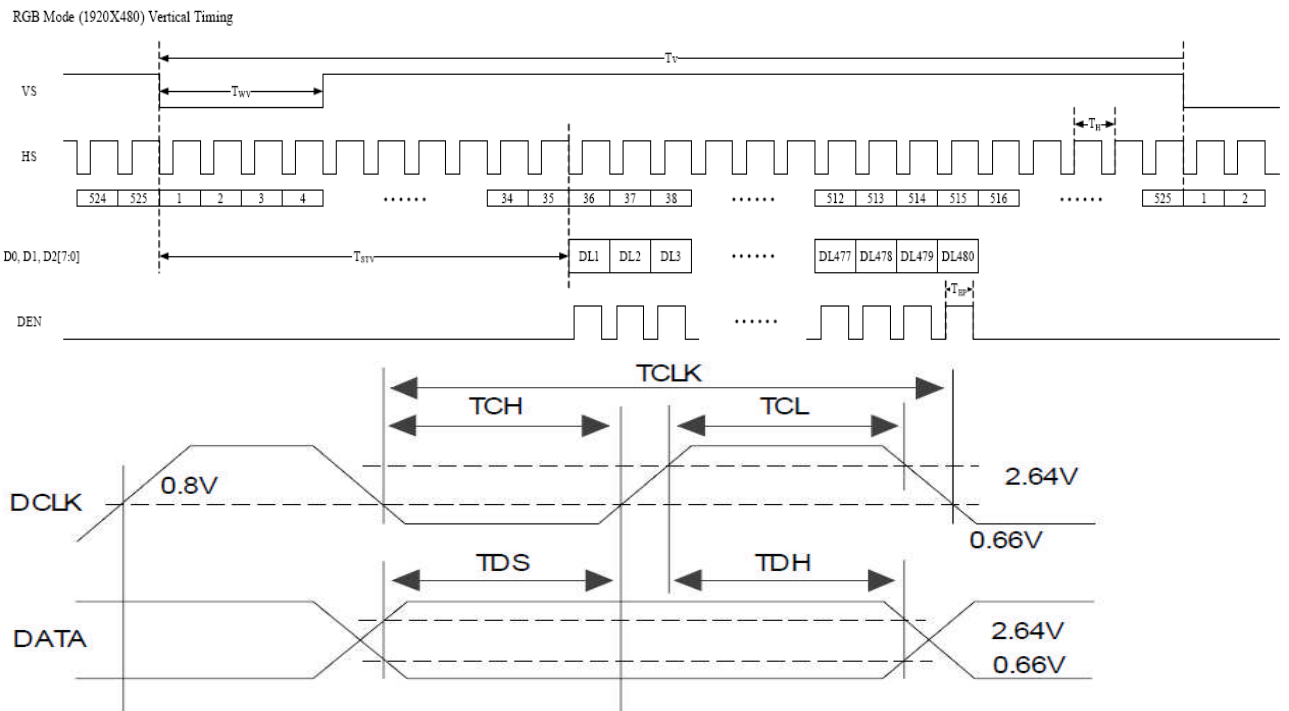

Figure 6-1-3 Digital RGB mode Horizontal timing for RESL[1:0]=10

7. Optical Characteristics

7.1 Optical characteristic of the LCD

The following items are measured under stable conditions. The optical characteristics should be measured in a dark room or equivalent state.

Measuring equipment: BM-5A, BM-7A

Top=25°C

Items	Symbol	Min.	Typ.	Max.	Unit	Note/Condition	
Brightness	--	200	250	--	cd/m2	--	
Response time	Tr	--	15	20	ms	θ=0°	
	Tf	--	25	35	ms		
Contrast ratio	CR	300	(450)	--	--	At optimized viewing angle	
Color Gamut	NTSC %	--	50	--	%	--	
Color Chromaticity (CIE 1931)	Red	Rx	0.565	0.615	0.665	--	θ=0° Normal Viewing Angle
		Ry	0.294	0.344	0.394		
	Green	Gx	0.257	0.307	0.357	--	
		Gy	0.512	0.562	0.612		
	Blue	Bx	0.090	0.140	0.190	--	
		By	0.080	0.130	0.180		
White	Wx	0.259	0.309	0.359	--		
	Wy	0.300	0.350	0.400			
Viewing Angle (12H)	Hor.	θ _R	55	65	--	Degree	CR≥10
		θ _L	55	65	--		
	Ver.	φ _H	55	65	--		
		φ _L	40	50	--		

Note:

*1. Test equipment setup

After stabilizing and leaving the panel alone shall be warmed up for the stable operation of LCM, the measurement should be executed. Measurement should be executed in a stable, windless, and dark room. Optical specifications are measured by Topcon BM-7A(fast) with a viewing angle of 2° at a distance of 50cm and normal direction.

*2. Definition of response time: Tr and Tf

The response time is defined as the following figure and shall be measured by switching the input signal for “black” and “white”.

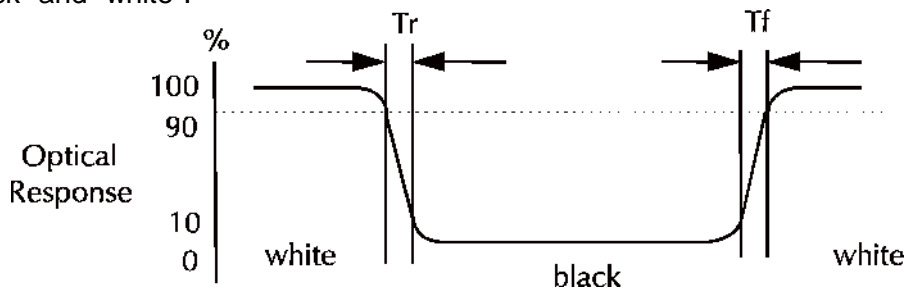

*3. Definition of contrast ratio:

$$\text{Contrast Ratio (CR)} = \frac{\text{Brightness measured when LCD is at "white state"}}{\text{Brightness measured when LCD is at "black state"}}$$

*4. Measured at the center area of the panel when all the input terminals of LCD panel are electrically opened.

*5. View Angle

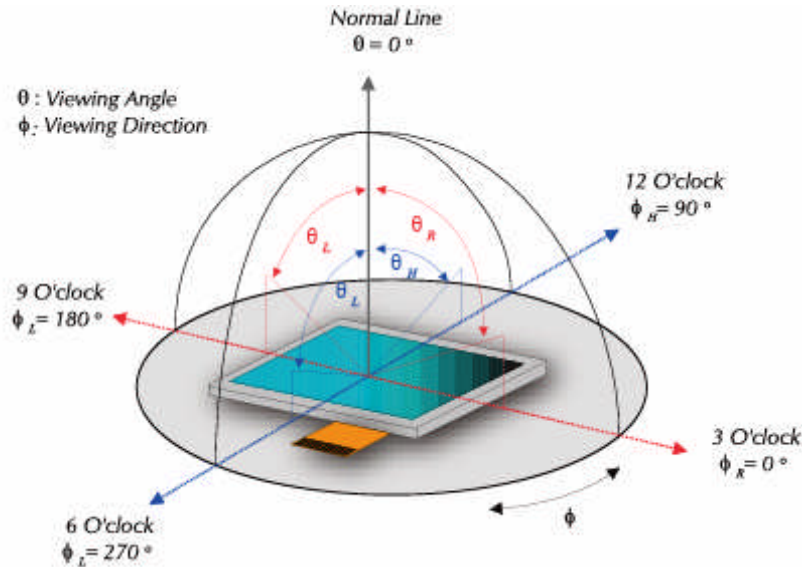

*6. **Definition of Luminance of White:** Luminance of white at the center points
Light Source of Back-Light Unit: LED Type

*7. **Definition of White Uniformity**

$$\text{White Uniformity} = \frac{\text{Min. luminance of white among 9-points}}{\text{Max. luminance of white among 9-points}} \times 100\%$$

*8. The definition of Color Gamut -Color Chromaticity CIE 1931

Color coordinate of white & red, green, blue at center point.

$$\text{Color Gamut : NTSC(\%)} = (\text{RGB Triangle Area} / \text{NTSC Triangle Area}) \times 100$$

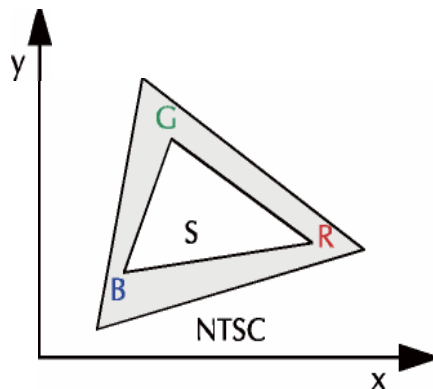

8. Function Characteristics

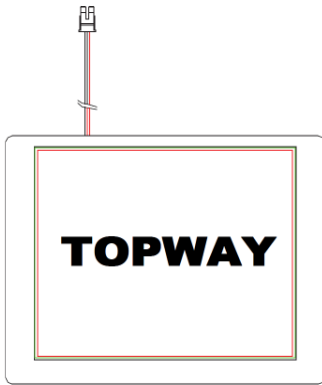

R/L=H, U/D=L

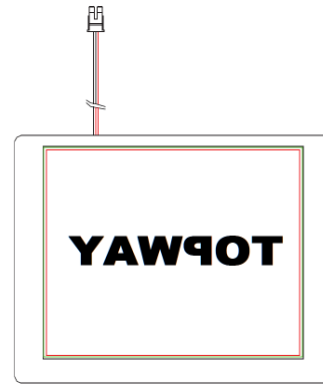

R/L=L, U/D=L

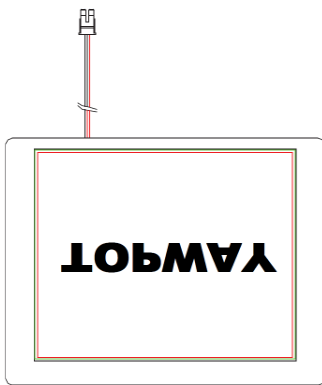

R/L=H, U/D=H

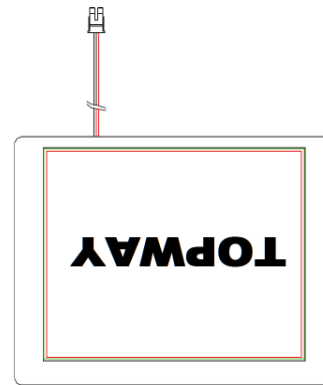

R/L=L, U/D=H

9. Precautions of using LCD Modules

Mounting

- Mounting must use holes arranged in four corners or four sides.
- The mounting structure so provide even force on to LCD module. Uneven force (ex. Twisted stress) should not applied to the module. And the case on which a module is mounted should have sufficient strength so that external force is not transmitted directly to the module.
- It is suggested to attach a transparent protective plate to the surface in order to protect the polarizer. It should have sufficient strength in order to the resist external force.
- The housing should adopt radiation structure to satisfy the temperature specification.
- Acetic acid type and chlorine type materials for the cover case are not desirable because the former generates corrosive gas of attacking the polarizer at high temperature and the latter causes circuit break by electro-chemical reaction.
- Do not touch, push or rub the exposed polarizers with glass, tweezers or anything harder than HB pencil lead. Never rub with dust clothes with chemical treatment. Do not touch the surface of polarizer for bare hand or greasy cloth.(Some cosmetics deteriorate the polarizer.)
- When the surface becomes dusty, please wipe gently with absorbent cotton or other soft materials like chamois soaks with petroleum benzine. Normal-hexane is recommended for cleaning the adhesives used to attach front / rear polarizers. Do not use acetone, toluene and alcohol because they cause chemical damage to the polarizer.
- Wipe off saliva or water drops as soon as possible. Their long time contact with polarizer

Operating

- The spike noise causes the mis-operation of circuits. It should be within the $\pm 200\text{mV}$ level (Over and under shoot voltage)
- Response time depends on the temperature.(In lower temperature, it becomes longer.)
- Brightness depends on the temperature. (In lower temperature, it becomes lower.) And in lower temperature, response time(required time that brightness is stable after turned on) becomes longer.
- Be careful for condensation at sudden temperature change. Condensation makes damage to polarizer or electrical contacted parts. And after fading condensation, smear or spot will occur.
- When fixed patterns are displayed for a long time, remnant image is likely to occur.
- Module has high frequency circuits. Sufficient suppression to the electromagnetic interference shall be done by system manufacturers. Grounding and shielding methods may be important to minimized the interference

Electrostatic Discharge Control

Since a module is composed of electronic circuits, it is not strong to electrostatic discharge. Make certain that treatment persons are connected to ground through wrist band etc. And don't touch interface pin directly.

Strong Light Exposure

Strong light exposure causes degradation of polarizer and color filter.

Storage

When storing modules as spares for a long time, the following precautions are necessary.

- Store them in a dark place. Do not expose the module to sunlight or fluorescent light. Keep the temperature between 5°C and 35°C at normal humidity.
- The polarizer surface should not come in contact with any other object. It is recommended that they be stored in the container in which they were shipped.

Protection Film

- When the protection film is peeled off, static electricity is generated between the film and polarizer. This should be peeled off slowly and carefully by people who are electrically grounded and with well ion-blown equipment or in such a condition, etc.
- The protection film is attached to the polarizer with a small amount of glue. If some stress is applied to rub the protection film against the polarizer during the time you peel off the film, the glue is apt to be torn on the polarizer. Please carefully peel off the protection film without rubbing it against the polarizer.
- When the module with protection film attached is stored for a long time, sometimes there remains a very small amount of glue still on the polarizer after the protection film is peeled off.
- You can remove the glue easily. When the glue remains on the polarizer surface or its vestige is recognized, please wipe them off with absorbent cotton waste or other soft material like chamois soaked with normal-hexane.

Transportation

The LCD modules should be no falling and violent shocking during transportation, and also should avoid excessive press, water, damp and sunshine.